

**M12 female 0° / RJ45 male 0° shielded Ethernet**

PUR 2x2xAWG22 shielded gn UL/CSA+dragchain 17m

Ethernet CAT5

Female straight – male straight

M12 – RJ45, 4-pole

D-coded

shielded

Transmission properties with channel transmission up to 100 m

Further cable lengths on request.

Plastic housings with good resistance against chemicals and oils.

The resistance to aggressive media should be individually tested for your application. Further details on request.

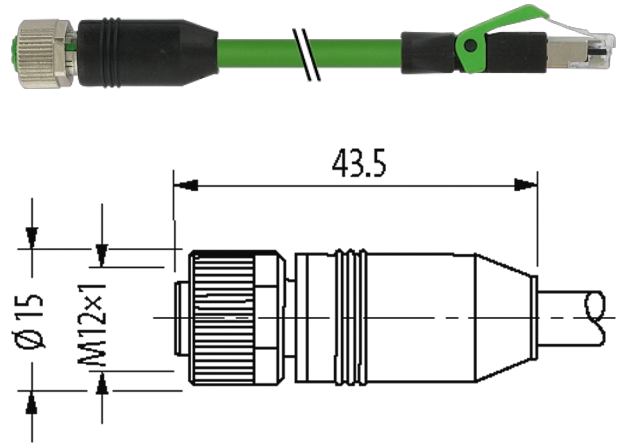
**Illustration**

Product may differ from Image

**Approvals**

\* only for products with UL/CSA approved cable

**More Info**

EtherNet/IP



**Form**

Form 44621

**Cables**

No./diameter of wires	2 × 2 × 0.34 mm <sup>2</sup>
Wire isolation	PE (wh, ye, bl, or)
C-track properties	3 Mio.
Jacket Color	green
Material (jacket)	PUR (UL/CSA)
Outer Ø	6.7 mm ±5%
Bend radius (moving)	12 × outer Ø

Temperature range (fixed)	-40...+80 °C
Temperature range (mobile)	-30...+70 °C
Cable identification	796
Approval (cable)	UL (AWM-Style 20233/11602), CSA; CE
Cable weight [g/m]	69,3
Material (wire)	Cu wire, bare
Resistor (core)	max. 55 Ω/km (20 °C)
Diameter (core)	2× 2× AWG22
Material (wire isolation)	PE
Wire-Ø incl. isolation	1.4 mm ±5%
Color/numbering of wires	wh, ye, bl, or
Shield	yes
	min. 85%
Material (jacket)	PUR
Outer-Ø (jacket)	6.7 mm ±5%
Color (jacket)	green
thermal resistance	flammwidrig nach UL 1581 Section 1060 (FT1), Section 1061 (cable flame), Section 1080 (VW-1) / IEC 60332-1-2
Nominal voltage	300 V
Temperature range (fixed)	-40...+80 °C
Temperature range (mobile)	-30...+70 °C
Bend radius (fixed)	5× outer Ø
Bend radius (moving)	12× outer Ø
No. of bending cycles (C-track)	max. 3 Mio. (25 °C)
Traversing distance (C-track)	max. 5 m (horizontal)
Travel speed (C-track)	max. 3.3 m/s
Acceleration (C-track)	max. 2 m/s <sup>2</sup>

#### Technical Data

Operating voltage	max. 60 V DC
Operating voltage (only UL listed)	30 V DC
Rated surge voltage	1.0 kV
Operating current per contact	max. 1.5 A
Transfer parameters	CAT5, Class D (ISO/IEC 11801:2002), (EN 50173-1)
Transfer rate	up to 100 Mbit/s full duplex
Material group	IEC 60664-1, category I
Coding	D-coded
LED display	no
Locking of ports	Screw thread (M12×1 mm) recommended torque 0.6 Nm, self-securing
Compression gland	M12 (SW13)
Protection	IP67 (M12) - IP20 (RJ45)
Locking material	Zinc die casting, matte nickel plated
Material	PUR
suitable for corrugated tube (internal Ø)	without

#### General data

Standards	DIN EN 61076-2-101 (M12)
Mounting method	inserted, tightened
Material (gasket)	FKM
Pollution Degree	3
Temperature range	-25...+85 °C, depending on cable quality

#### Commercial data

country of origin	DE
customs tariff number	85444290
EAN	4048879705165
eClass	27061801
Packaging unit	1

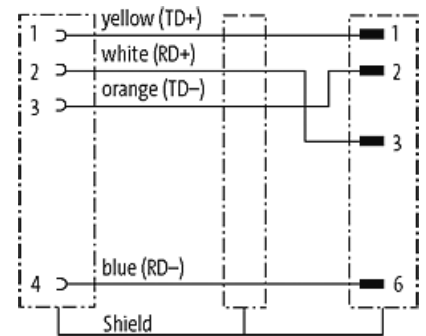
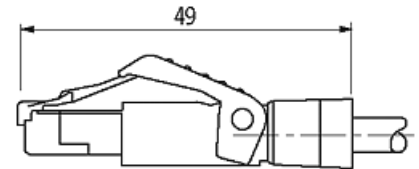
**Sketch**

Product may differ from Image